

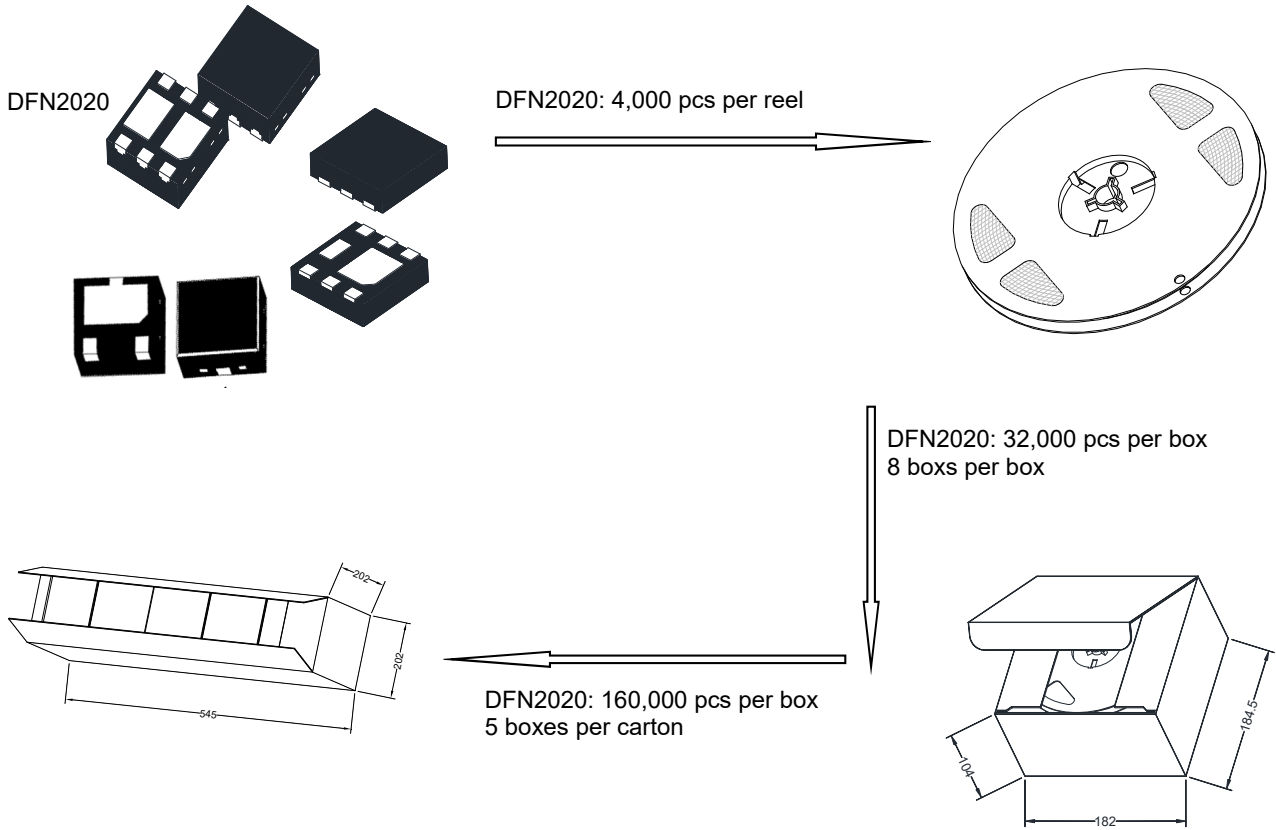





# Packaging Specification for 7" Reel DFN2020 Diodes & Transistor

1. The method of packaging and dimension are shown as below figure. (Dimension in mm)



## 2. Label

2.1 The information of inner box label must be listed: (Description of a sample label)

2.1.1	TYPE		means (Product) TYPE (Part No.)
2.1.2	P/O		means (Order No.) P/O (Part No.)
2.1.3	P/N		means (Customer No.) P/N (Part No.)
2.1.4	QTY		means (Product) Quantity (QTY)
2.1.5	D/C		means Dice Lot No. / Code (D/C)
2.1.6	P/C		means Production Code (P/C)
2.1.7	RMK		means Manufacturing Date (RMK)



2.2 The information of carton label must be listed:

- 2.2.1 TYPE
- 2.2.2 QTY

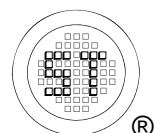

## Tape and Reel Specifications and Packaging Specifications for Surface Mounted Mold Diodes & Transistor

Embossed tape and reel is used to facilitate automatic pick and place equipment feed requirements. The tape is used as the shipping container for various products and requires a minimum of handling. The antistatic / conductive tape provides a secure cavity for the product when sealed with the “peel-back” cover tape.

- Two reel sizes available (7")
- DFN2020 in 8 mm Tape
- Used for automatic pick and place feed systems

Use the standard device title and add the required suffix as listed in the option table on the following page. Note that the individual reels have a finite number of devices depending on the type of product contained in the tape. Also note the minimum lot size is one full reel for each line item, and orders are required to be in increments of the single reel quantity.

DFN2020-3 in 8 mm Tape

DFN2020-6 in 8 mm Tape

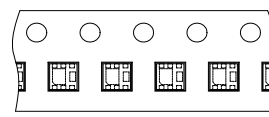
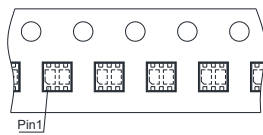
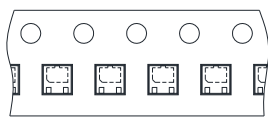

Direction  
of feed

### EMBOSSED TAPE AND REEL ORDERING INFORMATION

Package	Tape Width (mm)	Pitch		Reel Size		Devices Per Reel and Minimum Order Quantity
		mm	inch	mm	inch	
DFN2020	8	4 ± 0.1	0.157 ± 0.004	178	7	4,000

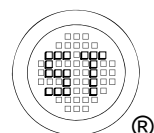

# Embossed Tape and Reel Data for DFN2020 Carrier Tape Specifications

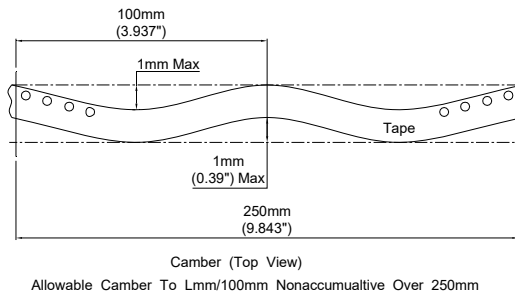
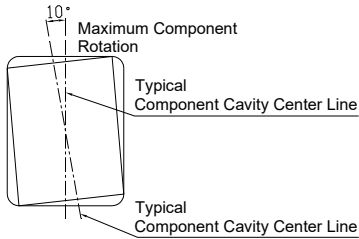
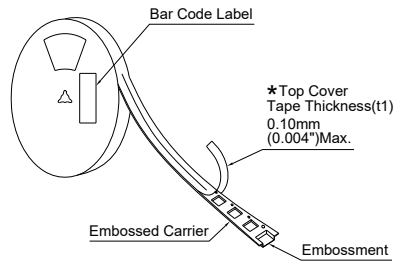
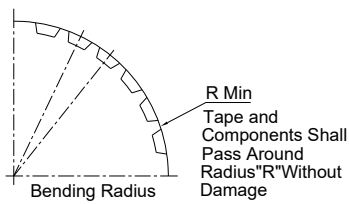
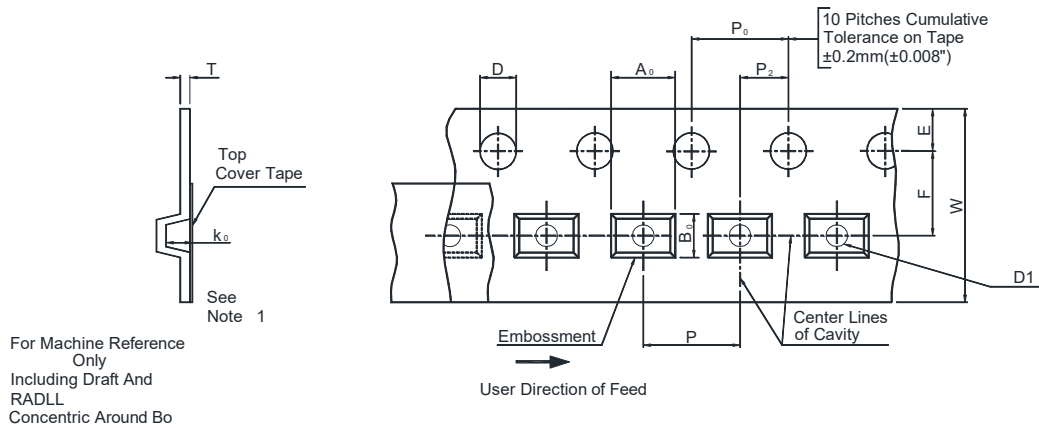

## Dimensions

Package	Tape Size	D	D1	E	F	P	P <sub>0</sub>	P <sub>2</sub>	R Min.	T Max.	W Max.
DFN2020	8 mm	1.5 +0.1 mm -0.0 (0.059")	1.3 mm Max (0.051")	1.75 ± 0.1 mm (0.069 ± 0.004")	3.5 ± 0.05 mm (0.138 ± 0.002")	4 ± 0.1 mm (0.157 ± 0.004")	4 ± 0.1 mm (0.157 ± 0.004")	2 ± 0.1 mm (0.079 ± 0.004")	25 mm (0.98")	0.25 mm (0.01")	8.3 mm (0.327")

Metric dimensions govern-English are in parentheses for reference only.

Note 1: A<sub>0</sub>, B<sub>0</sub>, and K<sub>0</sub> are determined by component size. The clearance between the components and the cavity must be within 0.05 mm min. to 0.5 mm max.

The component cannot rotate more than 10° within the determined cavity.

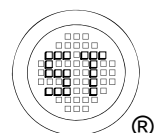

# Surface Mounted Reel Specifications

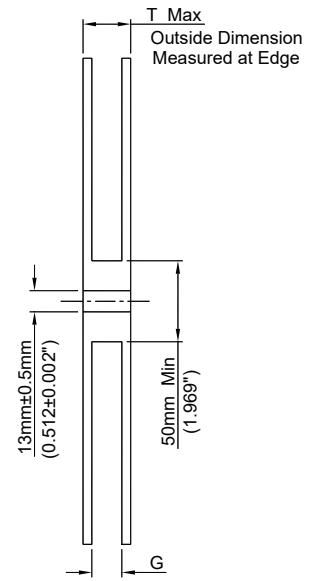
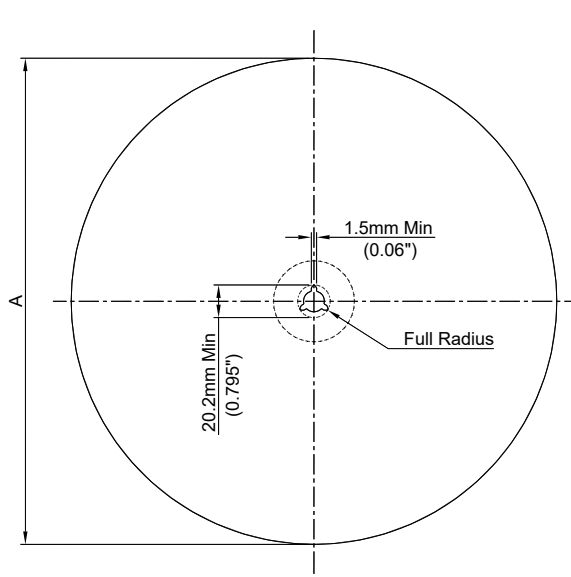

Inside Dimension  
Measured Near Hub

Size	A (Max.)	G	T (Max.)
8 mm	178 mm (7.007")	8.4 mm + 1.5 mm, -0.0 (0.33" + 0.059", -0.00)	14.4 mm (0.56")

Reel Dimensions

Metric Dimensions Govern - English are in parentheses for reference only

